

# LED Page Printer by Using a Polymerizing Toner

*Koichi Miyabe, Okidata, Mt. Laurel, New Jersey  
Subsidiary of Oki Electric Industry Co., Ltd., Tokyo, Japan*

## Introduction

OKI has been commercializing electrophotographic non-impact page printers with our original LED array head onboard. These units are called LED page printers. Oki's LED page printer OL400, OL800 series and the ML801ps have been popular as compact, high printing quality printers since their release. The compact LED page printer, by using a polymerizing toner, was developed for our new generation of page printers.

## Outline of Printer

Photo 1 shows an external view of this printer. Figure 1 shows the configuration. This printer is an electro photographic non-impact page printer with an LED array head onboard for writing. It is configured by a paper transport mechanism unit, an electro photographic processing unit, and a printing control unit. The electro photographic processing is ozone-free, hence there is no ozone odor present. The toner is a polymerization type that outputs high quality printing. For the printing control unit, the simplification of the hardware, along with high speed processing, were implemented by the development of an ASIC with a RISC CPU core.

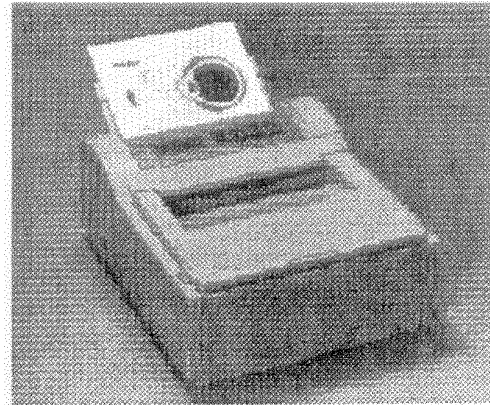

*Photo 1. External view of device.*

## Paper Transport Mechanism

The paper transport system consists of a paper feed unit, an electrophotographic processing unit, and a paper discharge unit. In the paper feed section a paper cassette is set at the bottom of the main frame, and paper is u-turned from the front of the main frame and fed into the main unit. This not only makes the main frame compact, but it also reduces the installation area of the printer (foot print).

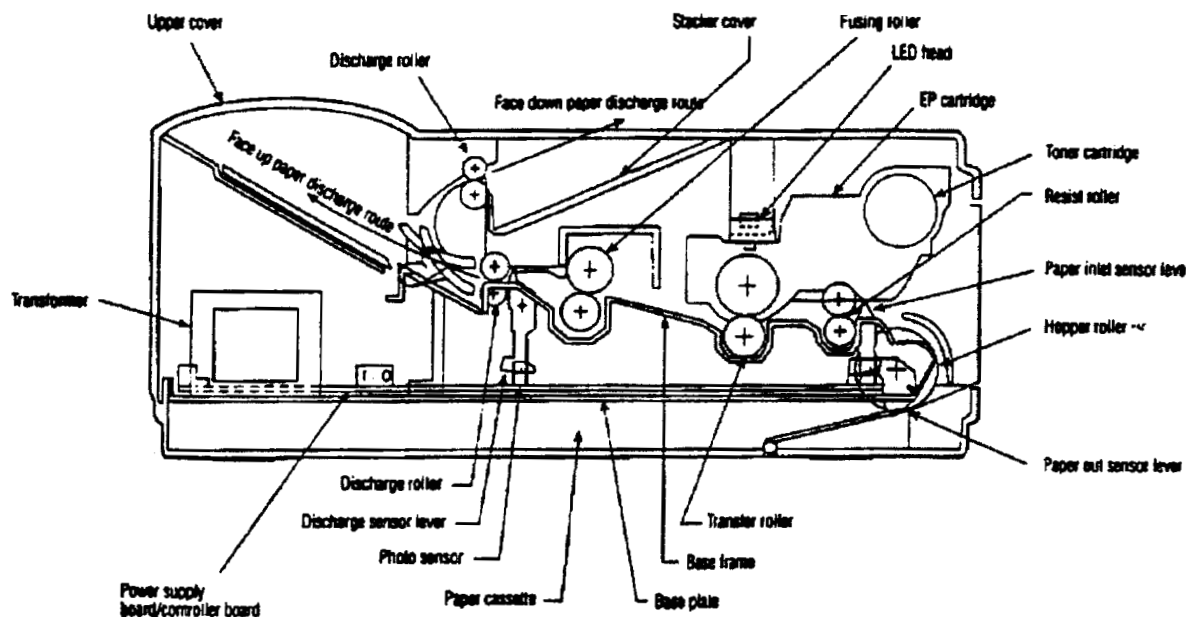

*Figure 1. Configuration of the printer.*

The printer uses the transfer roller method, in which paper transport and the transfer of a toner image are performed simultaneously. Paper on which a toner image was transferred is transported to the fusing unit, where the image is fused (bonded) to the paper by heat.

Photo 2 shows the base frame, a major part of the mechanism section. The base frame has multiple functions and is a solid mold. The LED array head is installed at the stacker cover, which is the receiver tray for papers that are discharged face down. If the stacker cover is opened, the LED array head and the EP (print) cartridge section separate, and the EP cartridge can easily be removed. At the same time, pressure of the fusing unit is released, so that paper can easily be removed from the fusing unit.

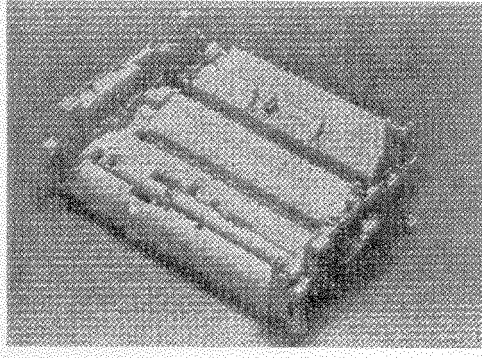

Photo 2. Base frame.

## Electrophotographic Process

Figure 2 shows an outline of the electrophotographic process. This process involves a charge that is evenly applied to the surface of the photosensitive drum; optical writing by the LED array head, a development that adheres toner to the electrostatic latent image on the photosensitive drum surface; a transfer, that electrostatically attracts the image to paper; cleaning, that cleans the photosensitive drum surface; and fusing, that fuses toner to the paper. This printer employs a newly developed ozone-free process and a polymerized toner.

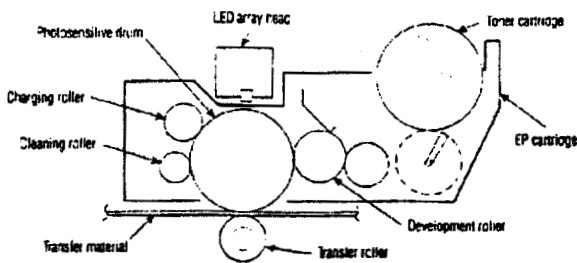

Figure 2. Printing process of electrophotography

## EP Cartridge

The photoelectric process includes an EP cartridge exchange system, which has an internal photosensitive drum and a development section. By exchanging the EP cartridge (Photo 3), high printing quality can easily be maintained. Toner can be added to the EP cartridge by exchanging the toner cartridge. EP cartridges have a long life, 20,000 sheets, keeping the price of consumables low. Toner in the toner

cartridge is supplied at a small outlet at the center of the cartridge. This outlet opens only the toner cartridge set at the EP cartridge. This means that toner cartridge exchange can be performed without soiling hands.

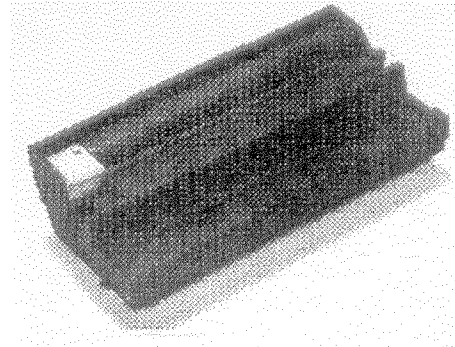

Photo 3. EP cartridge/toner cartridge.

## Ozone-free Process

Central to electrophotographic charging and transfer is a charging method by corona discharge. Corona discharge, however, is accompanied by ozone generation, and electrophotographic devices have a peculiar ozone odor. To eliminate this ozone odor, a roller method was adapted for charging and transfer. In the printer the charging roller and transfer roller contact the photosensitive drum and paper, charging directly, with no ozone generated. In this ozone-free process, a filter to remove ozone is unnecessary. Also, the air capacity of the cooling fan is reduced, further minimizing noise.

## Polymerized (*In Situ*) Toner

For the printer, a polymerized toner is used and an electro photographic process appropriate for this toner was developed. A conventional toner is manufactured by grinding thermally kneaded resin, carbon, etc., with a grinder. This makes the shape of a ground toner uneven, as shown in Photo 4.

“The conventional toner manufacturing process results in toners with a relatively wide size distribution. Many toner particles will be significantly larger or smaller than average. These toner particles will also be irregular in shape. The irregular size and shape of the toner particles make it difficult to put a uniform charge on them. As printer resolution increases, smaller toner particles are necessary to take advantage of increased resolution; however, small toner particles are especially difficult to charge evenly. Without a uniform charge, toner particles become very difficult to control in the machine and dusting can be problematic”.<sup>1</sup>

“In addition to dusting, another problem that results from non-uniform charging can be low toner yield, in either the development or transfer stage. At the extreme, this can result in void areas when printed. Also, toner particles which fall outside of the size specification must often be discarded, increasing waste and reducing manufacturing yields. Finally, conventional toner manufacturing is a very high energy use activity”.<sup>1</sup>

“*In situ* toner is manufactured by polymerizing monomers in a solution”.<sup>1</sup> “In the polymerization process, resin

monomers are mixed with pigments, charge agents, and additives in an aqueous solution that causes the resin to polymerize into tiny nearly-perfect spheres that are of a very uniform size if the process is carefully controlled. Special spraying and drying machinery is then used to convert the slurry of particles into a dry powder. Blending with special additives completes the process".<sup>2</sup>

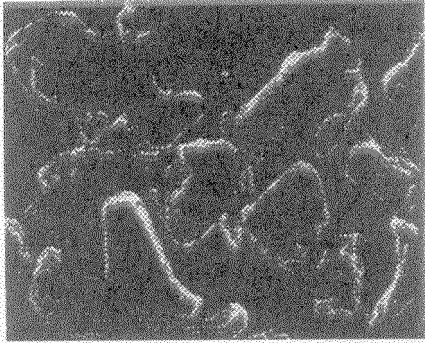

Photo 4. (a) Ground Toner.

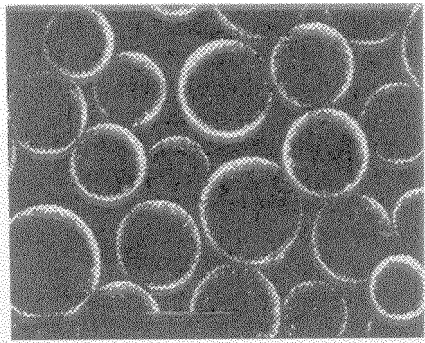

Photo 4. (b) Polymerized toner.

Uniform particles make it possible to impart a much more even charge on the toner particles than is currently possible with conventionally manufactured toners. "When toner particles have a uniform charge distribution, the particles become much easier to control within the machine, as they are transferred from the toner supply and finally onto the paper. Very small toner particles are necessary to take advantage of higher resolution printing".<sup>1</sup>

With an appropriately matched photoreceptor, very high quality images can be expected. In situ toner should fill solids evenly, and fine lines and small dots (required for text and gray scale patterns) should likely be free of stray particles. In addition, the toner should transfer from the photoreceptor to the paper with close to 100% accuracy. Little additional cleaning should be required. In low-end printers, the ability to avoid a hard cleaning blade should significantly increase photoreceptor life. High control over the movement of toner particles in the machine translates into less dusting and a reduced need for cleaning or maintenance".<sup>1</sup>

"Theoretically, the process used to make in situ toners is expected to result in extremely high manufacturing yields. While conventional toner manufacturing results in some waste in the classifying step to remove toner particles which are outside of the size specification, the *in situ* process is expected to result in almost no waste".<sup>1</sup>

If a polymerized toner is used for printing, the selective adhesion to electrostatic latent images is high during the development process, and high resolution printing is possible. Also, in the transfer process, transfer efficiency becomes quite high, achieving a sufficient printing density even for envelopes and cardboard surfaces. In the electrophotographic process of the printer, optimization that matches the polymerized toner was performed at each section, such as using a roller method to electrically attract toner in the cleaning process.

## Charging/Development

Charging is performed by applying a DC voltage directly to the charging roller in contact with the photosensitive drum surface.

The charging roller is made of semiconductive rubber. If resistance reaches  $10^7 \Omega$  or more, charging becomes  $10^5 \Omega$  or less, the photosensitive drum may be damaged. Therefore, we developed a rubber material that has little resistance dispersion. The charging potential of the photosensitive drum is determined by the DC voltage, and if resistance is within the range shown above, stable charging is possible. Also, we made the LED array head more compact than conventional heads.

Development is performed by a contact type nonmagnetic mono-component development system, which is the same as conventional models. The development roller is made of semiconductive rubber, that rotates when contacting the photosensitive drum. The development roller functions as a development electrode. An electric line of force from the electrostatic latent image runs toward the development roller, and an electric line of force that attracts toner can be achieved in a wide exposure area.

Also, since a high resolution latent image can be reproduced, an even density can be acquired at the center of solid black printing as well, and a high resolution image can be faithfully reproduced.

## Transfer

Transfer materials, such as paper and envelopes, are placed on the photosensitive drum surface, and an electric charge with a reverse polarity to the toner, is applied from the back of the material using the transfer roller. In this way toner on the photosensitive drum is transferred to the transfer material. The transfer roller is made of semiconductive sponge, and is pressed against the photosensitive drum at a constant pressure. In the case of an envelope and cardboard, an air layer is pushed out by transfer roller pressure, therefore transfer efficiency is high. If the transfer roller pressure is high, the ground toner is pressed to the photosensitive drum, causing transfer problems. Part of characters come out white. However, since the polymerization toner is spherical, this problem does not occur.

## Toner Recycling Method

In the OKI LED (OL) Series LED method electrophotographic non-impact page printer, the engineers have been trying very hard to keep wastes to a minimum by lengthening the life of consumables through the toner recycle method

and they have succeeded in achieving this goal. In a typical electrophotographic printer, toner removed by the cleaning process is placed into a waste container (which may be part of the one-piece EP cartridge/toner unit) and not captured for re-use. In order to lengthen the life of the EP cartridge, waste toner which accumulates in the cleaning area must be used.

OKI has developed a toner recycle method and solved this problem. In our original toner recycle method, toner that accumulates in the photoconductive drum after transfer is cleaned and returned to the developer unit by the recycle carrier mechanism and thus to be reused. Because the transfer residual toner is re-used, waste toner does not accumulate inside the EP cartridge, and toner can be added by replacing the toner cartridge. Because of this method, we have succeeded in increasing the life of the EP cartridge (over that of one-piece units) almost six times that of the one-unit type EP cartridge.

In our new series, we have made further improvement in the toner recycle method. The transfer residual toner is cleaned by the cleaning roller (see Figure 2) during every rotation. Because the capacity of the cleaning roller to hold toner, however, is very small, the toner is carried along with the rotation of the photoconductive drum. This toner is collected by the developer roller after passing the charger roller and re-used. As seen in the above explanation, the EP cartridge of this company has been simplified and is compact

with fewer parts, all of which have been realized through the elimination of the recycle carrier mechanism. In addition, the life of the EP cartridge has become 20,000 pages, which is about six times that of the one-unit type cartridge.

## Conclusion

The new generation of OKI LED Page Printers is based on very substantial advancements in the electro photographic technology, the most significant of these are the use of polymerized toner, an ozone-free charging system and a waste toner recycling system which extends toner and electro-photographic drum life.

## References

1. *Hard Copy Supplies, Product/Technology Issues*, July 19, 1993; published by BIS Strategic Decisions, Norwell, MA, USA.
2. *The Hard-Copy Observer*, August 1993; published by Lyra Research Inc., Newton, MA, USA.
- *OKI Technical Review*, Issue 147, Vol. 59; March 1993, K. Ito, T. Ito, Y. Ohta and S. Nakajima; published by Oki Electric Industry Co., Ltd., Tokyo, Japan.
- *OKI Technical Review*, Issue 139, Vol. 55; 1988 (Japanese Version), Ito, Akutsu, published by Oki Electric Industry Co., Ltd., Tokyo, Japan.