

A New Technique for Measuring Charge Σq and Mass Σm Values of Toner Particles (Part II)

Keiji Taniguchi[†] Yoichi Yamamoto*, Hiroaki Yamamoto[†] and Jun Mizukami[†]
[†]Information Science Dept., Fukui University, Fukui, Japan
 *Product Development Laboratory, SHARP Corporation, Nara, Japan

Abstract

We present here some other new information in addition to the contents of the reference [1].

The major items are as follows:

- (1) Behavior of toner particles put on the lower electrode is analyzed as a one shot motion of the cantilever.
- (2) The transit time of toner particles needed to fly between the two electrodes is numerically calculated by the Runge-Kutta algorithm.
- (3) The frequency of charge Σq to mass Σm ratio of toner particles is shown as experimental result.

Introduction

We have already presented a new method for measuring charge Σq and mass Σm values of toner particles.¹ Here, we show some other new information in addition to the contents of reference [1] about the design of the measurement system of toner parameters. The contents of this paper are as follows: system configuration, procedures for measuring the electrical parameters of toners, behavior of toner particles put on the lower electrode, measurement for circuit current caused by charged toner particles, transit time of toner particles, and experimental results. This technique is different from the reference [2] in the following points. At first, toner particles are thrown up by the vibration of the lower electrode, and voltage between electrodes is increased steps of ΔV . By this operation, charge Σq is calculated from the circuit current induced by the toner particles which arrive at the upper electrode. Mass Σm value is directly calculated from charge Σq , the distance between electrodes, the voltage applied across two electrodes. In the technique shown in reference [3], the procedure for calculating charge Σq is as same as our one. But the procedure for calculating Σm is different from our techniques. In their measurement, mass Σm is calculated from the shift of the resonance frequency of the electrode.

System Configuration

Figure 1 shows the schematic system configuration which has been already proposed.¹ The forces which influence toner particles between the parallel electrodes is assigned to be the some of the Bimage force f_0 , Coulomb force f_1 , and gravity force f_2 are shown in Figure 2.

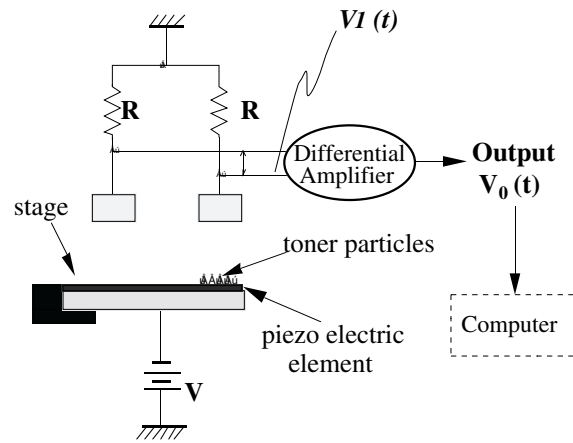

Figure 1. The measurement circuit.

- (1) The image forces:

$$f_0 = q^2/16\pi\epsilon_0 x^2 \quad (1)$$

$$f_0 = q^2/16\pi\epsilon_0 (d-x)^2 \quad (2)$$

where f_0, f_0 are the image forces caused by the lower electrode and upper one, respectively. Furthermore, x, q, d and ϵ_0 are the distance between the center of the toner particle and the inner surface of the lower electrode, the charge value of the toner particle, the gap distance between electrodes, and the permittivity of the gap space, respectively.

- (2) The Coulomb force:

$$f_1 = q(V/D) \quad (3)$$

where V is the voltage applied across the parallel electrodes.

- (3) The gravity force:

$$f_2 = mg \quad (4)$$

where m and g are the mass of the toner particle and the acceleration of the gravity ($9.8m/sec^2$), respectively.

In order to lift a toner particle from the lower electrode to the upper one, it is necessary to satisfy the following relation.

$$f_1' + f_0' \geq f_0 + f_2 \quad (5)$$

From the above equations, the following relation can be obtained.

$$q(V/D) \geq mg + f_0 - f_0' \quad (6)$$

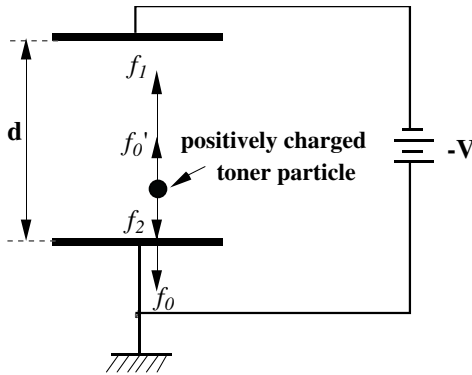

Figure 2. Forces acting on a toner particle.

As shown in Table 2 of reference [2], the influence of the image force which acts on the toner particle put on the lower electrode is very strong. Therefore, high voltage must be applied between the two electrodes. In order to reduce this voltage, we have proposed a technique using the piezoelectric element driven by the pulsed voltage for reducing the image force which acts on a toner particle. By this operation, toner particles may be vertically thrown toward the upper electrode. As the result at the center of the gap between two electrodes, Equation (6) may be simplified by the cancellation of two image forces acting on the charged toner particle in the following:

$$V = mgd/q \quad (7)$$

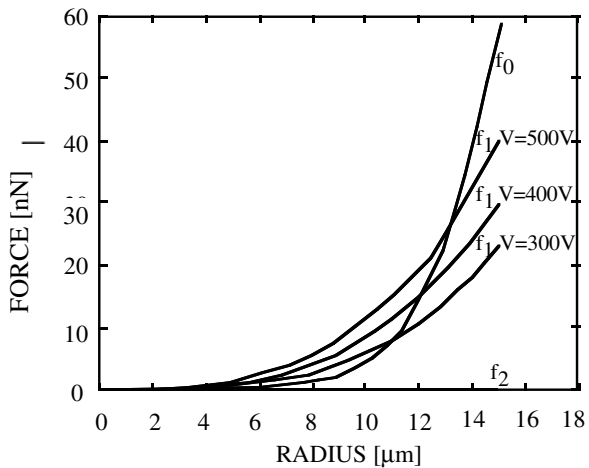

Figure 3. A numerical example of the relationship forces acting on a toner particle between radius r of a spherical toner particle and V . (in the case of $x = r$).

In case of a mass of toner particles n , the values of electrical charge $\sum q_i$ and mass $\sum m$ can be calculated by the following equation.

$$\sum q_i = \frac{1}{AR} \int_{t_1}^{t_2} V_0(t) dt \quad (8)$$

$$V_0(t) = AV(t) \quad (k = 1, 2, \dots)$$

$$\sum m_i = \sum q_i \cdot \left(\frac{V_k}{gd} \right) \quad (i = 1, 2, 3, \dots, n) \quad (9)$$

where A is the amplification factor of the differential amplifier, R is the serial resistance and $V_0(t)$ is the output voltage of the amplifier shown in Figure 1.

Figure 3 indicates the voltage that is necessary to separate the toner particle adhered to the lower electrode and then to lift to the upper electrode. In the case of the cancellation of two image forces acting on the toner particle, Figure 4 shows that the voltage regarded to the toner particle can be decreased.

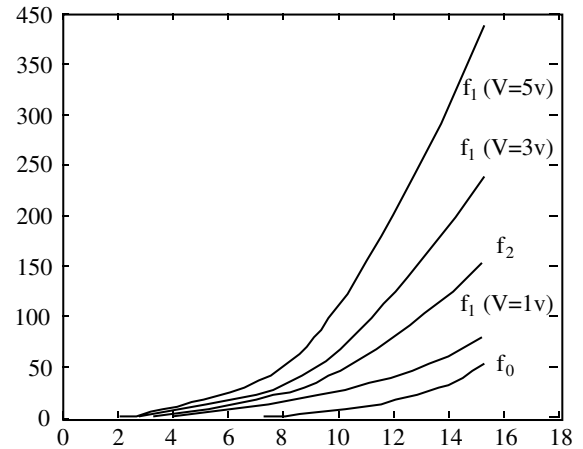

Figure 4. A numerical example of the relationship between r and force depicted as a parameter V . (in the case of $x = d/2$).

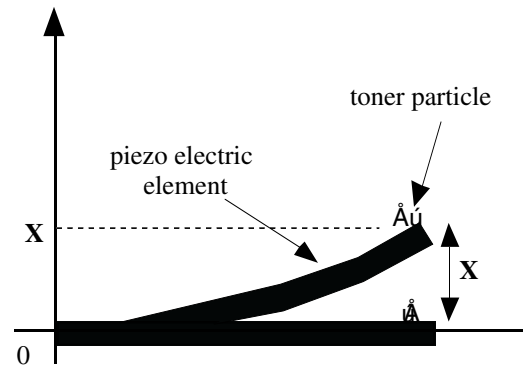

Figure 5. The behavior of toner particle adhered to the lower electrode.

Behavior of a Toner Particle Caused by the Vibration of the Lower Electrode

This paragraph describes the behavior of a toner particle caused by vibration of the lower electrode as shown in Figure 5. The toner particle adheres to the lower electrode by the image force. Let us consider the condition for separating the toner particle from the lower electrode. As mentioned previously, the lower electrode is driven by a step function. In this case, the following equation can be written:

$$(M + m) \frac{d^2 x}{dt^2} = F - kx \quad (10)$$

where x , M , m , F , and k are displacement of the toner particle, mass of the lower electrode (piezo electric element),

mass of the toner particle, driving force, and spring constant, respectively. From Equation (10), x can be obtained for $t > 0$ as:

$$x(t) = -\frac{F}{x} \cos\left(\sqrt{\frac{F}{M+m}}t\right) + \frac{F}{k} \quad (11)$$

From Equation (11), the acceleration

$$\alpha \left(\alpha = \frac{d^2x}{dt^2} \right)$$

of the lower electrode is given as:

$$\alpha = \frac{F}{M+m} \cos\left(\sqrt{\frac{F}{M+m}}t\right) \quad (12)$$

The condition that the toner particle leaves the lower electrode can be given by the following relation.

$$m\alpha + q\frac{V}{d} - mg \geq f_0 - f_0' \quad (13)$$

Consequently, from Equations. (1), (2), (12), and (13), the following relation must be satisfied.

$$m\left(\frac{F}{M+m} \cos\sqrt{\frac{k}{M+m}}t - g\right) + q\frac{V}{d} \geq \frac{q^2}{16\pi\epsilon_0 r^2} - \frac{q^2}{16\pi\epsilon_0 (d-r)^2} \quad (14)$$

where r is the radius of toner particle.

Figure 6 shows a numerical example of the relationship between radius r and drive force F as a parameter q/m .

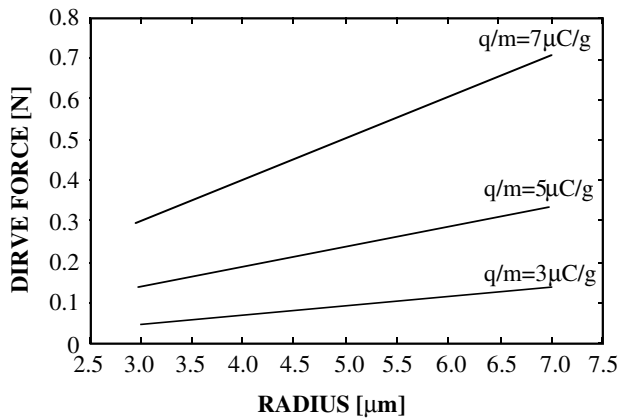

Figure 6. A numerical example of the relationship between radius r and drive force F for different value of q/m .

Transit Time of a Toner Particle

In this section, we describe the transit time of a toner particle jumping between two electrodes. The electrical signal generated by the charged toner particle depends on the transit time of the particle.

Here, the resultant force Q which acts on a toner particle is described by the following relation:

$$Q(x) = f_0' + f_1 - f_0 - f_2 = \frac{q^2}{16\pi\epsilon_0 (d-x)^2} + q\frac{V}{d} - \frac{q^2}{16\pi\epsilon_0 x^2} - mg \quad (15)$$

where x is the distance from the lower electrode.

$$\alpha(x) = \frac{1}{m} \left(\frac{q^2}{16\pi\epsilon_0 (d-x)^2} + q\frac{V}{d} - \frac{q^2}{16\pi\epsilon_0 x^2} - mg \right) \quad (16)$$

where we have assumed that the speed of a toner particle is nearly equal to 0 (m/s) at the center of the gap between two electrodes. Figures 7 and 8 show the transit time of the toner particle as a parameter of radius of a toner particle and q/m , respectively.

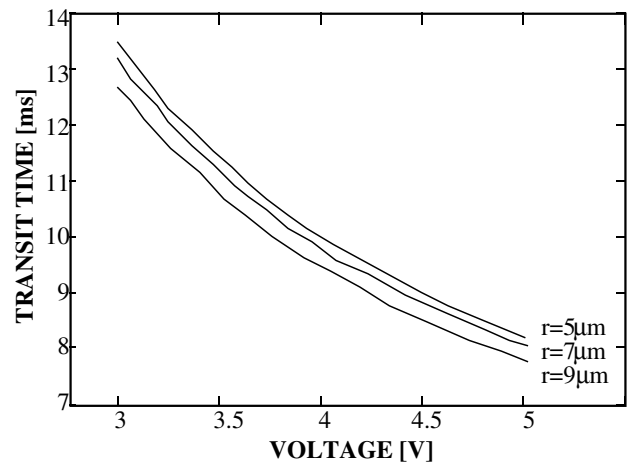

Figure 7. A numerical example of the relationship between voltage V and transit time for various radii r of the toner particle.

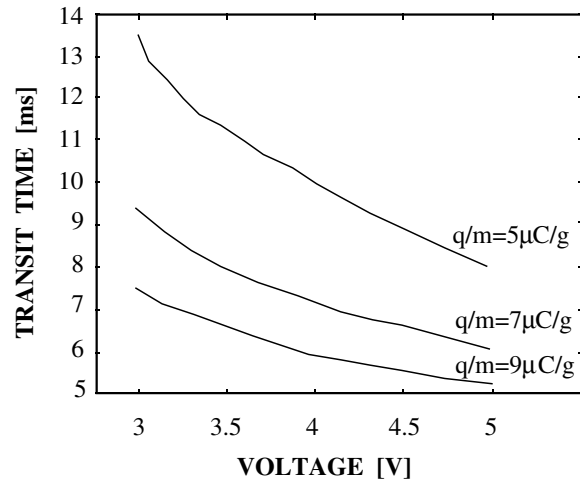

Figure 8. A numerical example of the relationship between voltage V and transit time as a parameter of q/m .

Procedures for Measurement

Proposed procedures for the measurement of the values of Σq and Σm for toner particles are as follows:

- (1) Initially, a voltage V_k applied between two electrodes is set to V_1 (for example $V_1 = 0$, where V_k is the width of quantization of the voltage).
- (2) Give a one shot motion (or sinusoidal motion) of the lower electrode in order to approximately neglect image force acting on toner particles, and calculate the values of Σq and Σm by the following equations:

$$\Sigma q_i = \left(\frac{1}{AR} \right) \int_{t_1}^{t_2} V_0(t) dt$$

$$\Sigma m = \Sigma q_i = \left(\frac{V_k}{gd} \right)$$

where A , R , $V_0(t)$ and d are the amplification factor of the differential amplifier, the serial resistance connected the sensing circuit, the output voltage of the differential amplifier and the distance between the two electrodes, respectively.

- (3) V_k is increased as: $V_k \leftarrow V_k + \Delta V_k$

where ΔV is the width of quantization of the voltage. Iterate between steps (2) and (3).

- (4) if $V_k = V_w$ (V_w is the maximum value of V), then the measurement is complete.

The Experimental Result

The histogram of q/m is shown in Figure 9. From the result of measurement, the minimum value of q/m is $4.41[\mu\text{C/g}]$ and the maximum value of one is $13.3[\mu\text{C/g}]$. The average value and the standard deviation are $7.81[\mu\text{C/g}]$ and 3.36 , respectively.

Conclusion

In this paper, we proposed a new technique for measuring the electrical characteristic of toner particles. Using this technique, we can easily obtain the distribution of q/m .

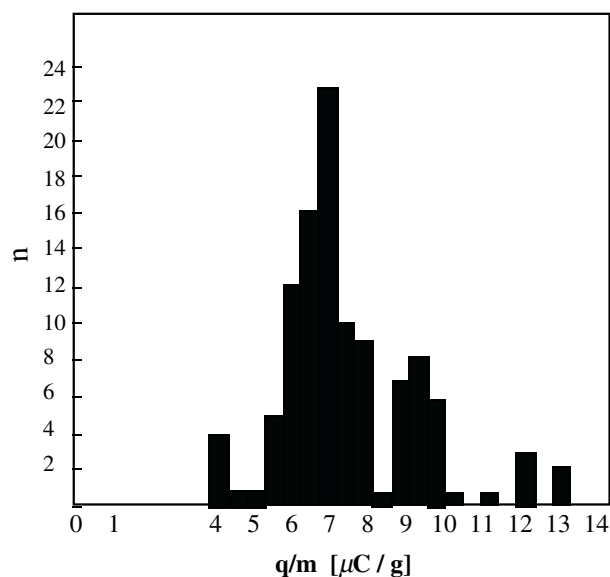

Figure 9. Distribution of q/m .

References

1. Y. Yamamoto, K. Taniguchi, H. Yamamoto, A New Technique for Measuring Charge Σq and Mass Σm Values of Toner Particles. *IS & T's Eleventh International Congress on Advances in Non-Impact Printing Technologies*, 1995; (see page 186, this publication).
2. Y. Yamamoto, K. Taniguchi, H. Yamamoto, Y. Takahara, A New Method for Measuring the Image-Force to Gravity Force Ratio of a Toner Particle. *IS & T's Twelfth International Congress on Advances in Non-Impact Printing Technologies*, 1996; (see page 332, this publication).
3. D. S. Rimai, M. C. Zaretsky, B. Primerano, J. F. Laukaitis, A Piezo Electric Sensor for In-Situ Monitoring of Xerographic Developers, *IS & T's Tenth International Congress on Advances in Non-Impact Printing Technologies*, 1994.